

V 405F-1

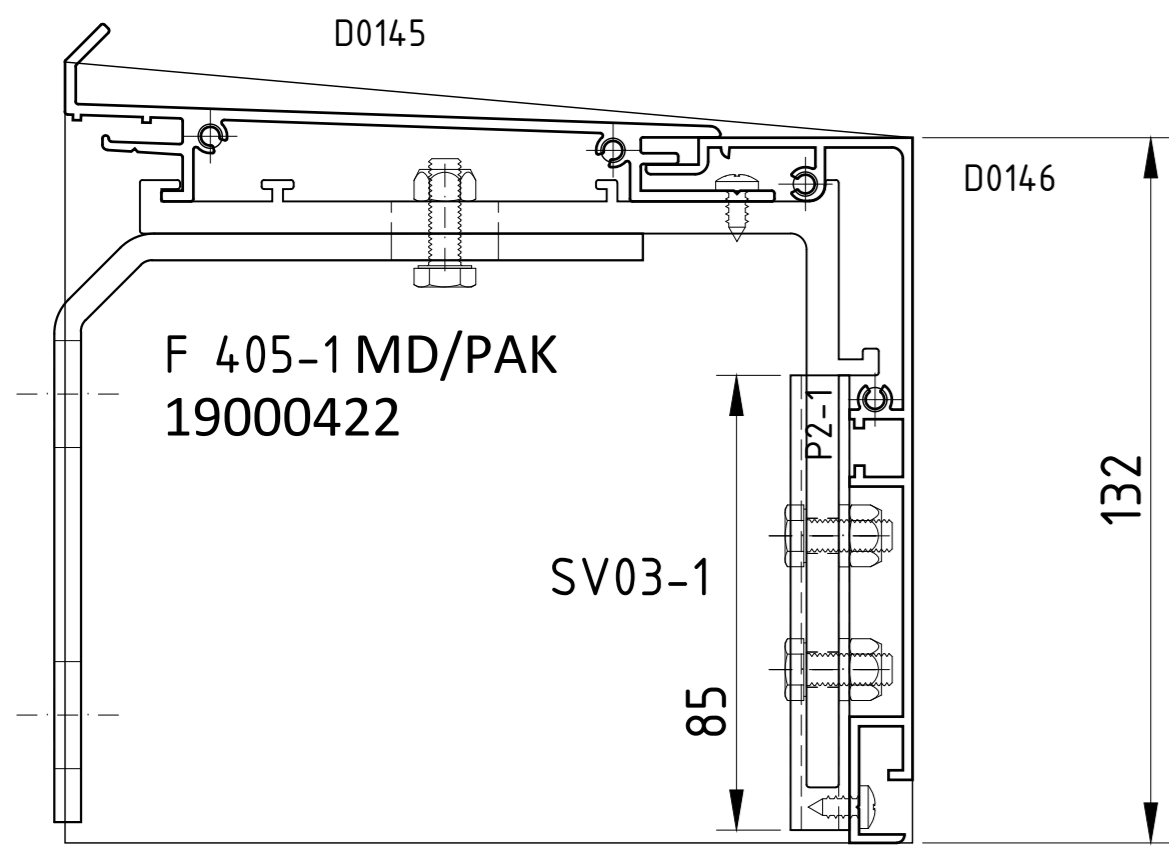

V 405F-2

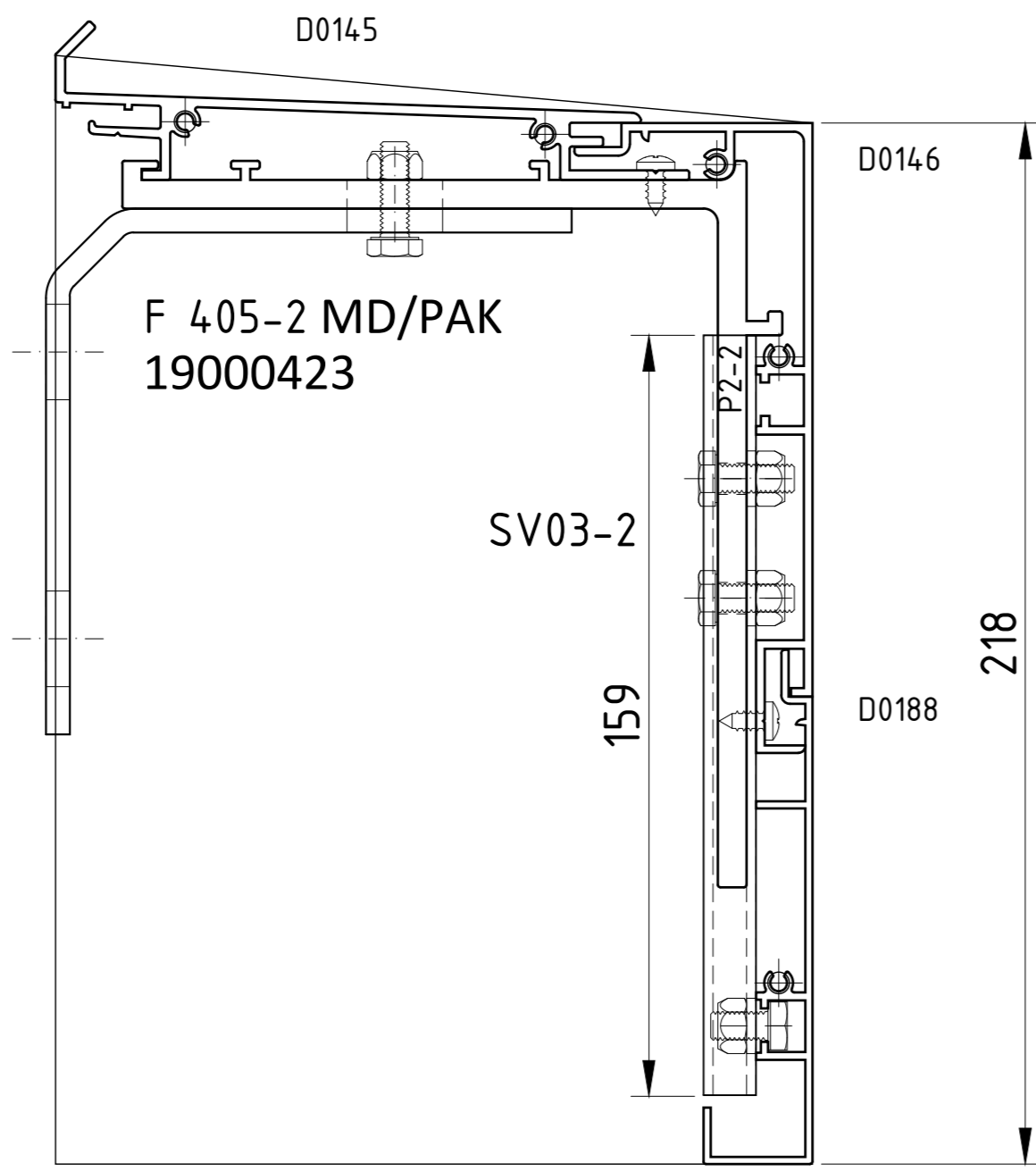

V 405F-3

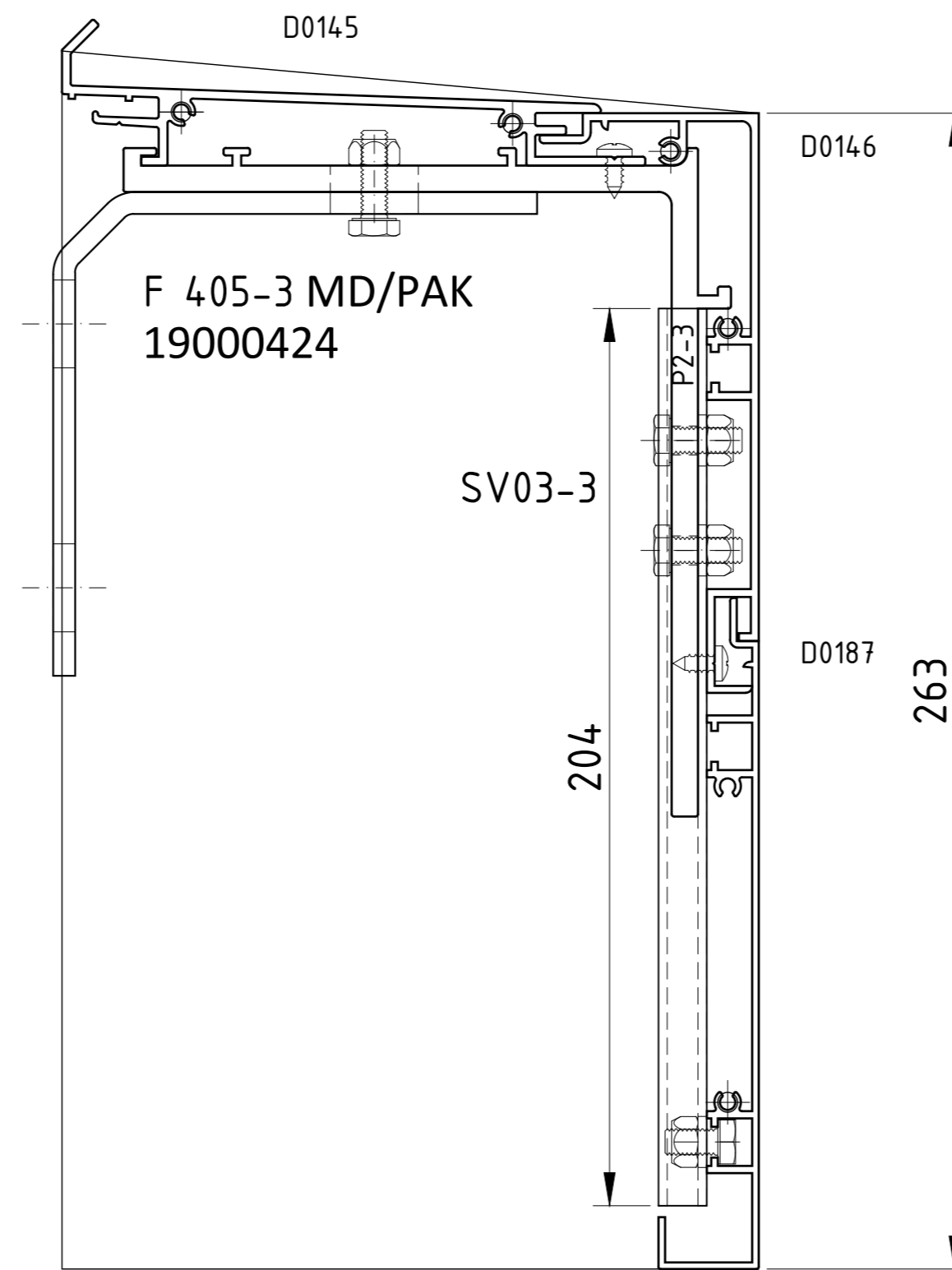

V 405F-4

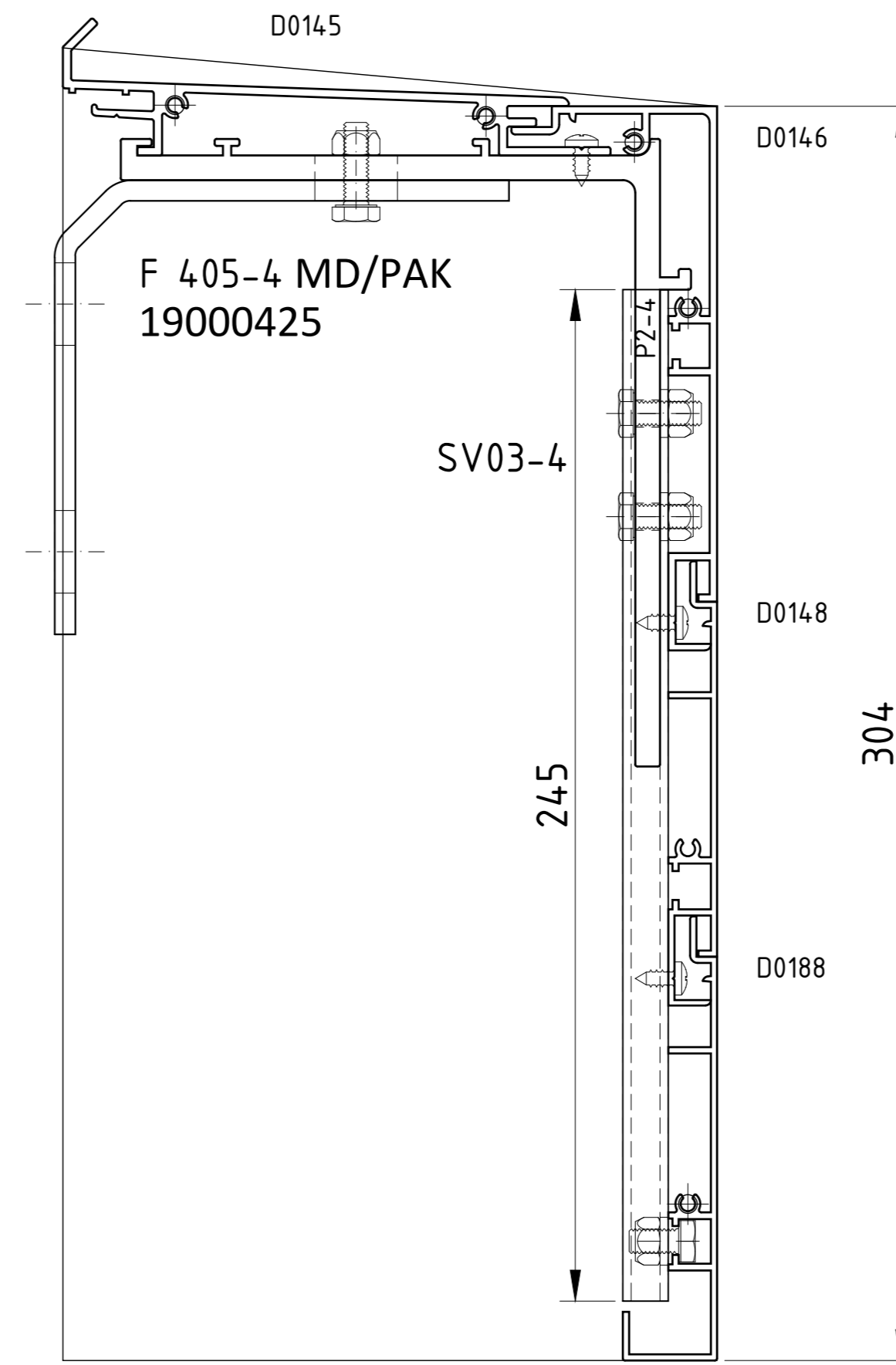

V 405F-5

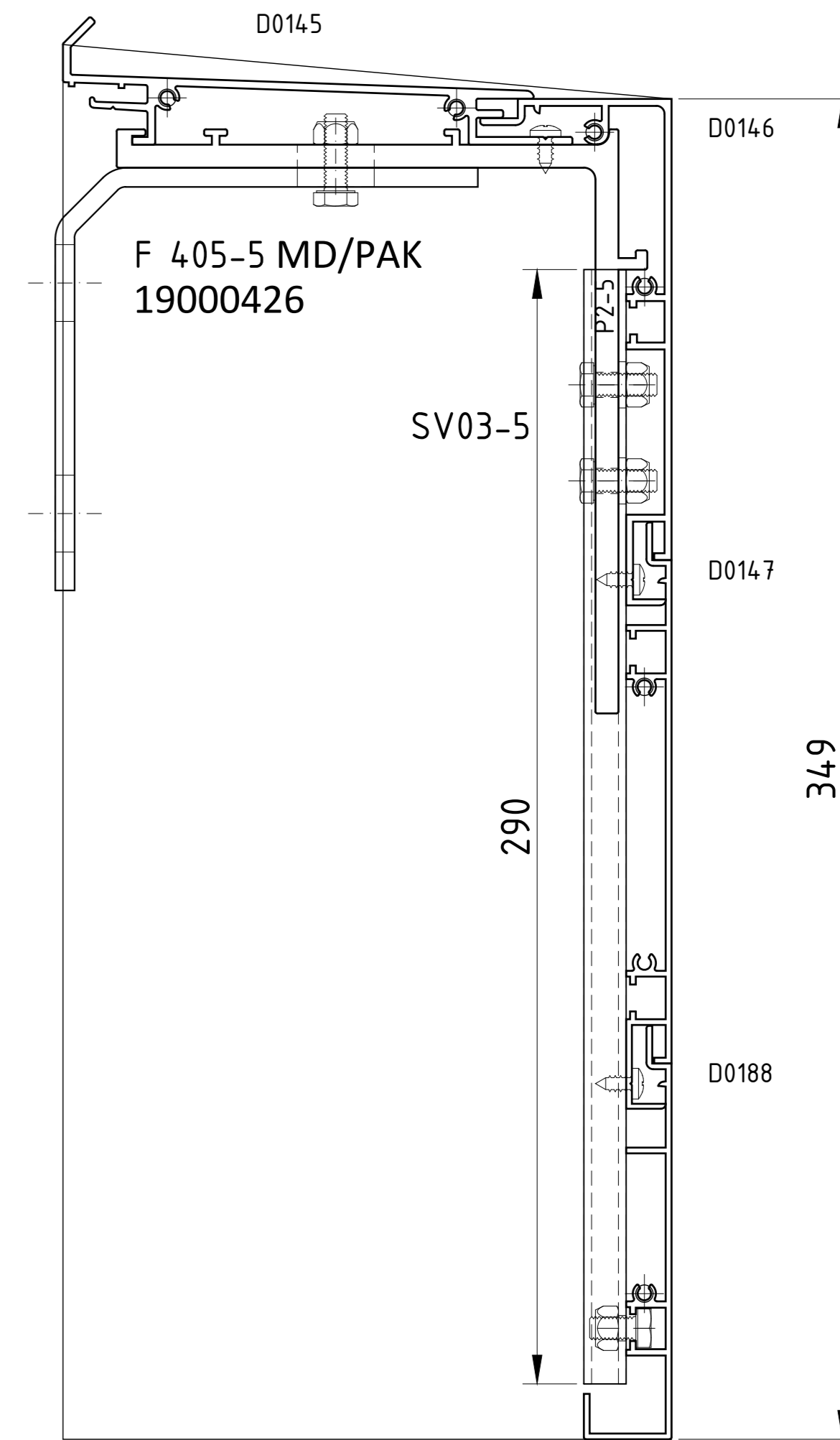

V 405F-6

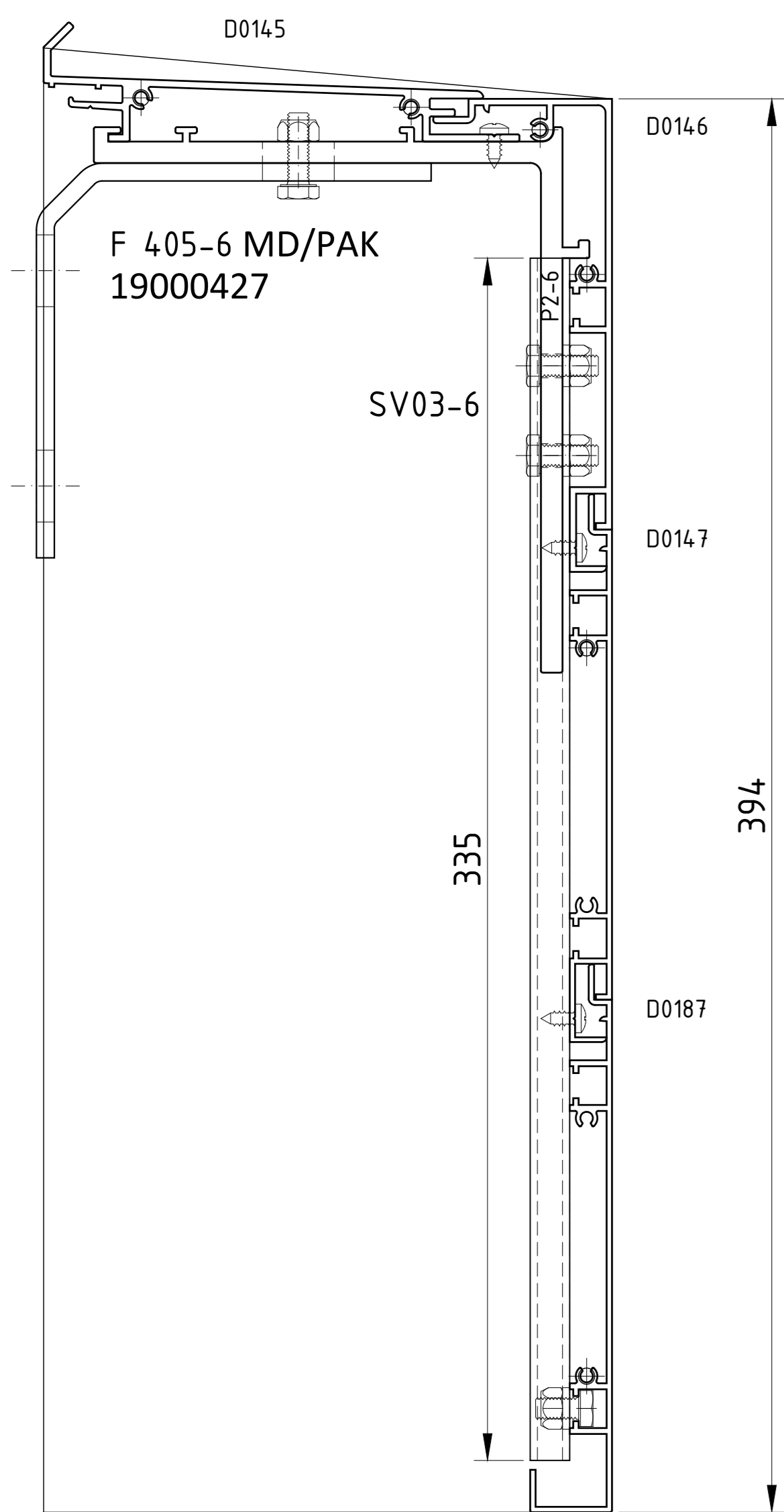

V 405F-7

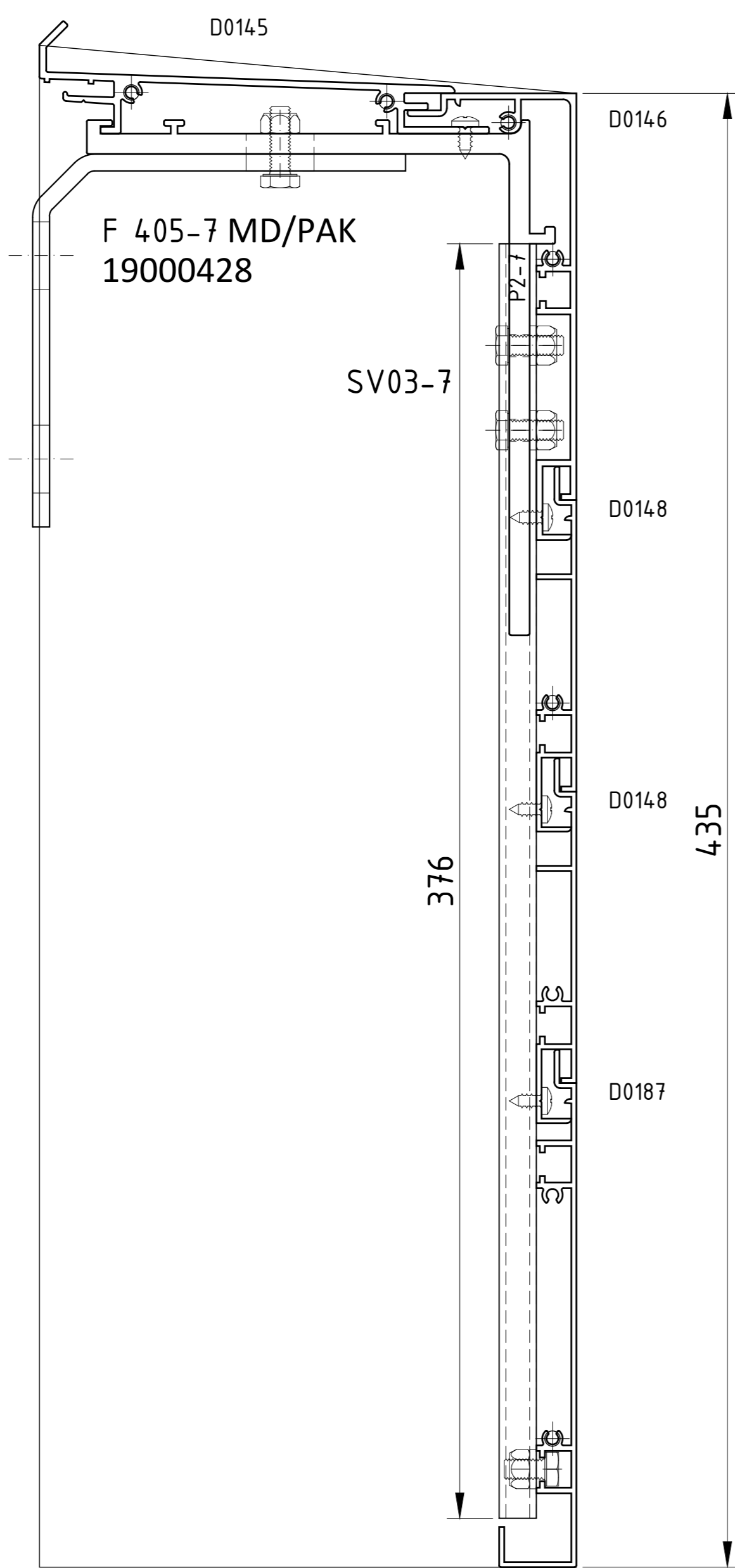

V 405F-8

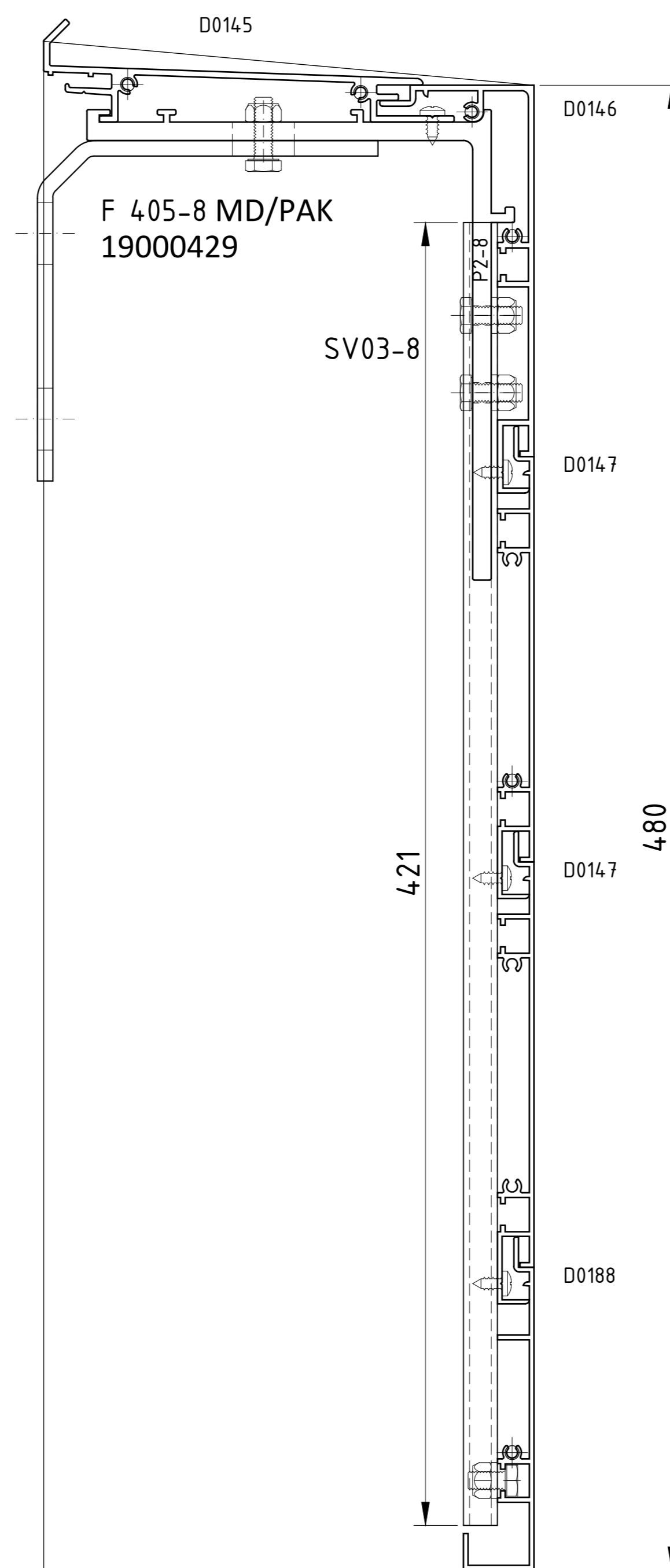

V 405F-9

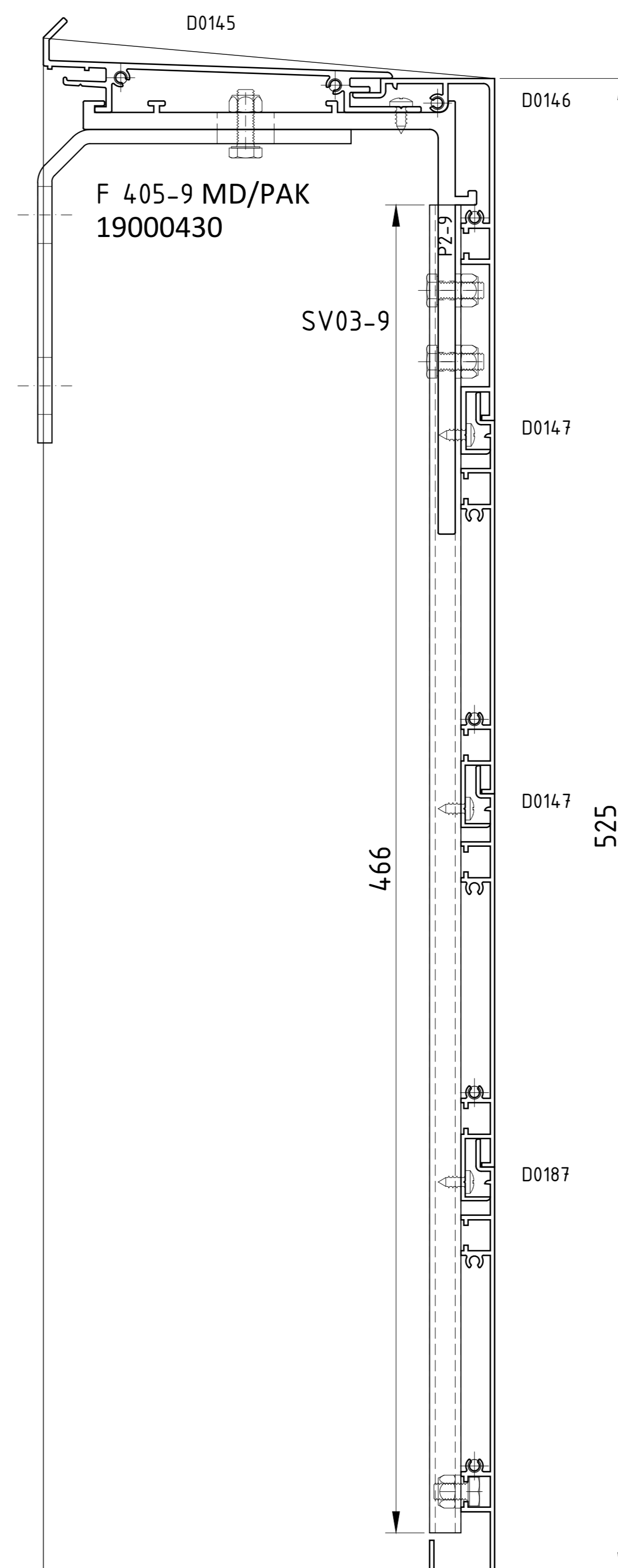

 MODEL SYSTEM ITALIA Daylighting solutions	Data 19/09/22	Nr. disegno
	Revisione 00	
Descrizione	Disegnato da	
V405F	M.P.	
Veletta fissaggio frontale	Scala	
RIPRODUZIONE VIETATA PER LEGGE	non in scala	