

H1

265

100

85

290

130

12,5

uscita cavo motore

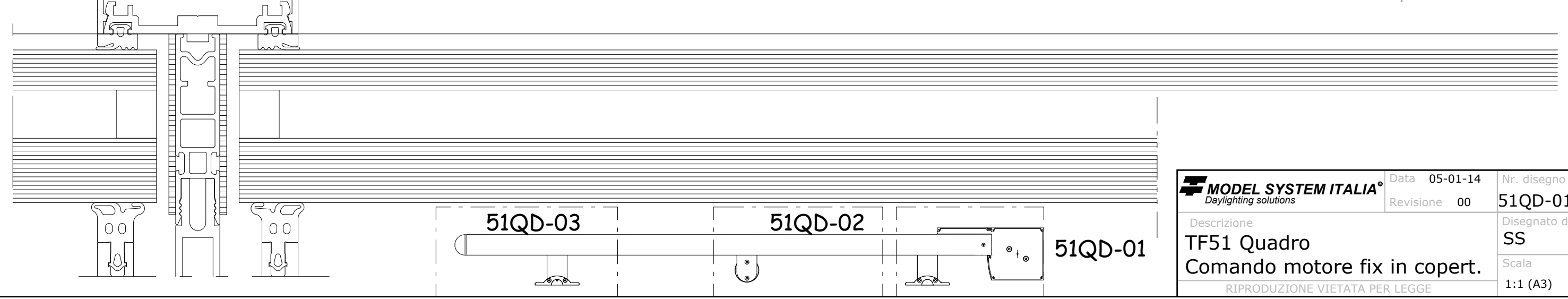
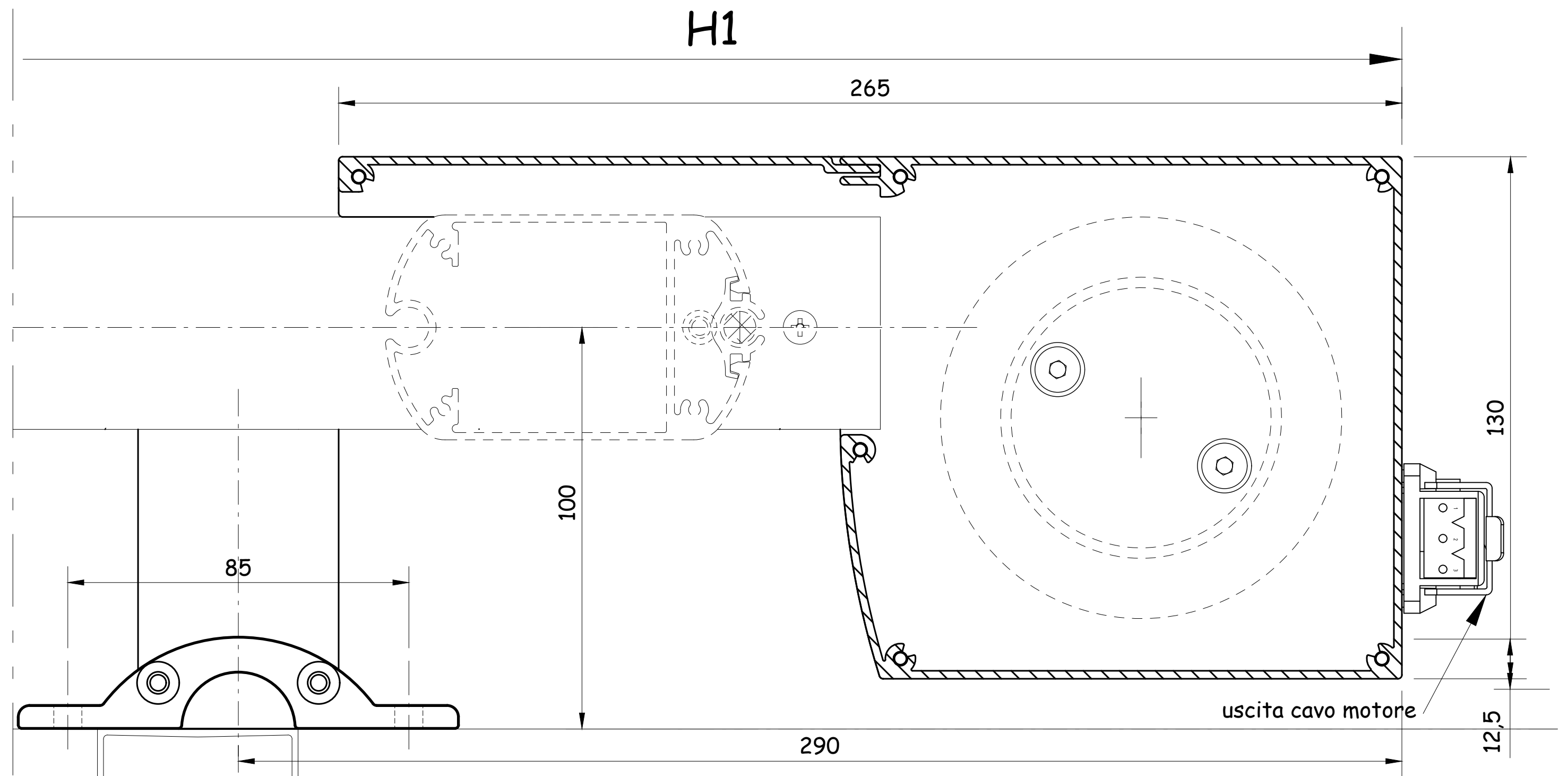

 MODEL SYSTEM ITALIA® Daylighting solutions	Data	05-01-14	Nr. disegno	51QD-01
	Revisione	00	Disegnato da	SS
Descrizione TF51 Quadro Comando motore fix in copert.			Scala 1:1 (A3)	
RIPRODUZIONE VIETATA PER LEGGE				

terminale

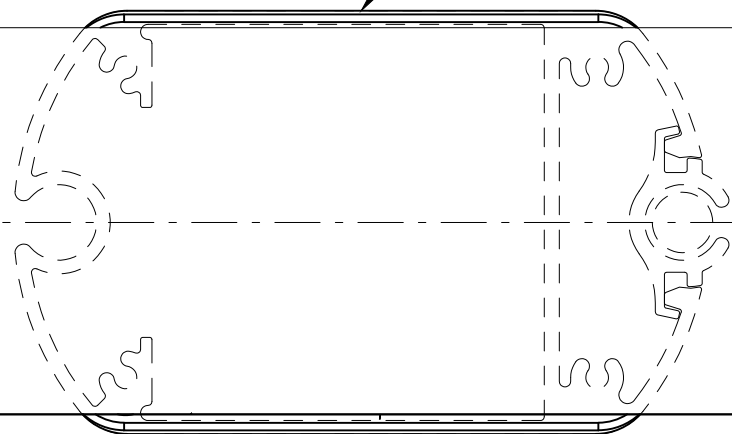

barra trasversale
fissa per h1>2900mm

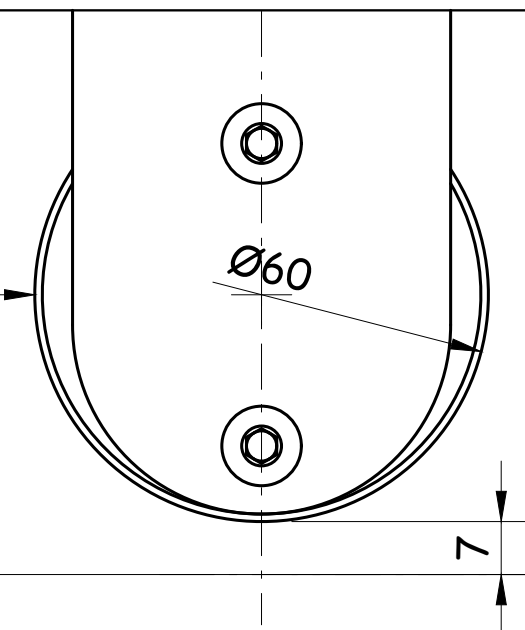

Ø60

7

100

staffa di fissaggio
guida

85

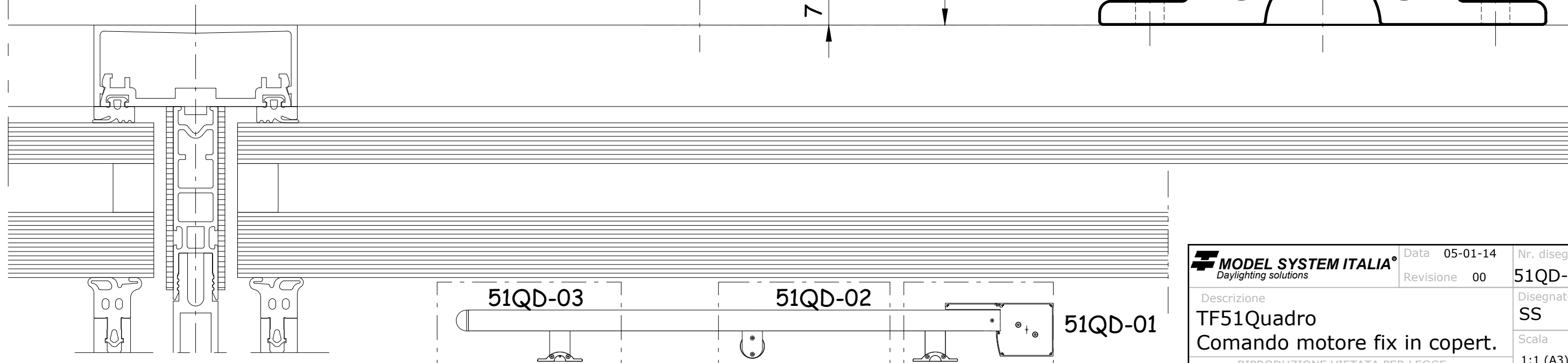
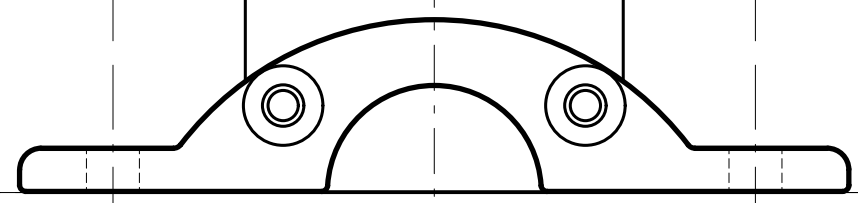

51QD-03

51QD-02

51QD-01

 MODEL SYSTEM ITALIA Daylighting solutions	Data	05-01-14	Nr. disegno	51QD-02
	Revisione	00	Disegnato da	SS
Descrizione TF51Quadro Comando motore fix in copert.			Scala	1:1 (A3)
RIPRODUZIONE VIETATA PER LEGGE				

H1

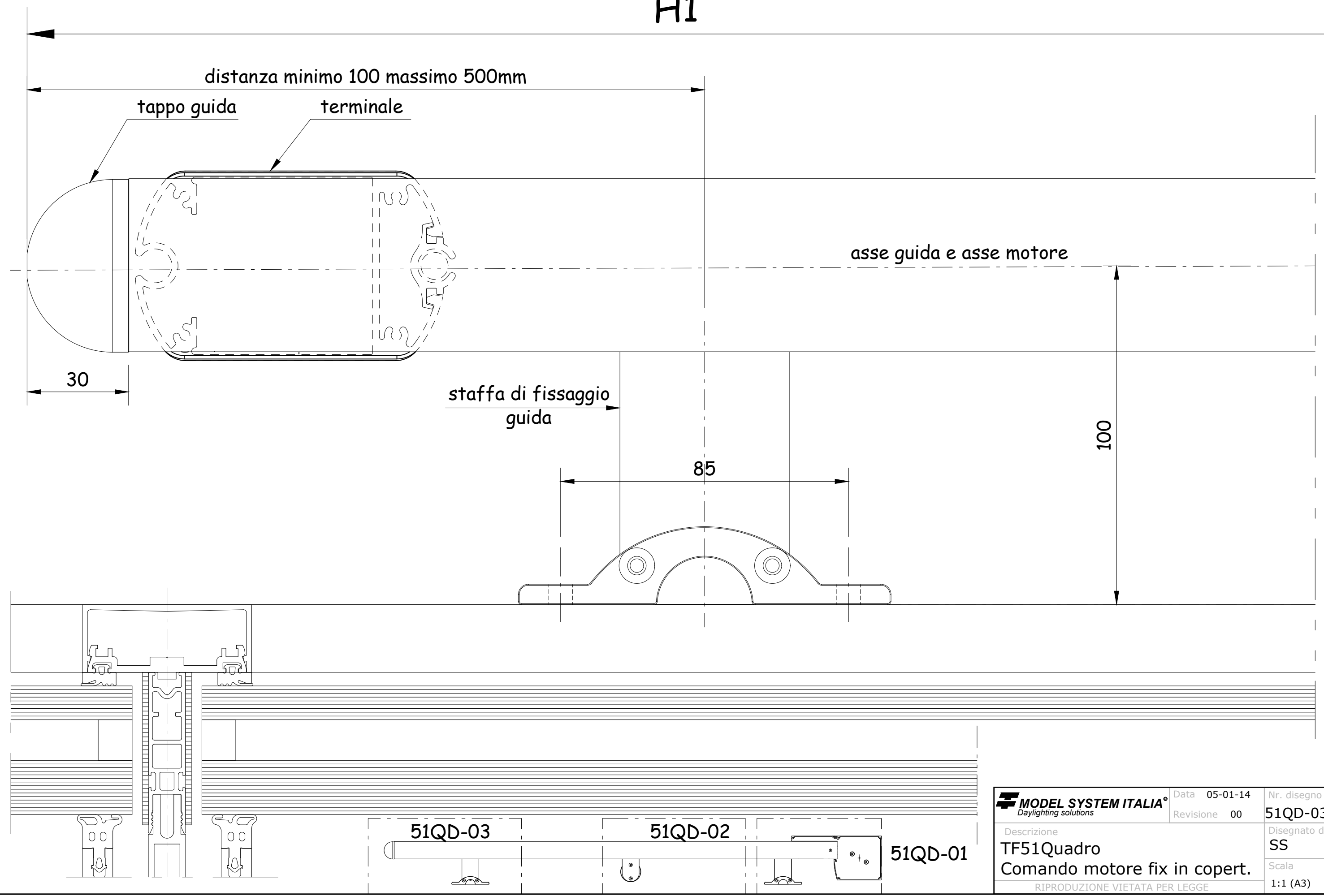

 Daylighting solutions	Data 05-01-14	Nr. disegno
	Revisione 00	51QD-03
Descrizione	Disegnato da	
TF51Quadro	SS	
Comando motore fix in copert.	Scala	
RIPRODUZIONE VIETATA PER LEGGE	1:1 (A3)	